

# EN

**OPERATING MANUAL**  
CO<sub>2</sub> AIR QUALITY MONITOR

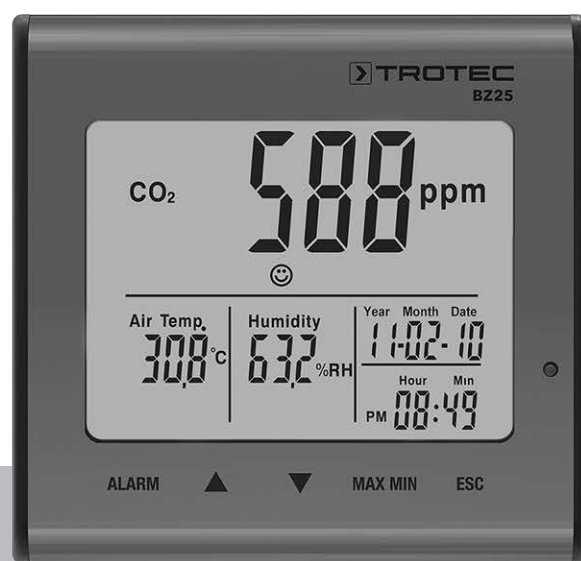

**Table of contents**

Notes regarding the operating manual..... 2

Safety ..... 2

Information about the device..... 3

Transport and storage..... 5

Operation ..... 5

Maintenance and repair ..... 6

Disposal ..... 6

**Notes regarding the operating manual**

**Symbols**



**Warning of electrical voltage**

This symbol indicates dangers to the life and health of persons due to electrical voltage.



**Warning**

This signal word indicates a hazard with an average risk level which, if not avoided, can result in serious injury or death.



**Caution**

This signal word indicates a hazard with a low risk level which, if not avoided, can result in minor or moderate injury.

**Note**

This signal word indicates important information (e.g. material damage), but does not indicate hazards.



**Info**

Information marked with this symbol helps you to carry out your tasks quickly and safely.



**Follow the manual**

Information marked with this symbol indicates that the operating manual must be observed.

You can download the current version of the operating manual and the EU declaration of conformity via the following link:



BZ25



<https://hub.trotec.com/?id=43283>

**Safety**

**Read this manual carefully before starting or using the device. Always store the manual in the immediate vicinity of the device or its site of use!**



**Warning**

**Read all safety warnings and all instructions.**

Failure to follow the warnings and instructions may result in electric shock, fire and / or serious injury.

**Save all warnings and instructions for future reference.**

This appliance can be used by children aged from 8 years and above and persons with reduced physical, sensory or mental capabilities or lack of experience and knowledge if they have been given supervision or instruction concerning use of the appliance in a safe way and understand the hazards involved.

Children shall not play with the appliance. Cleaning and user maintenance shall not be made by children without supervision.

- Do not use the device in potentially explosive rooms.
- Do not use the device in aggressive atmosphere.
- Do not immerse the device in water. Do not allow liquids to penetrate into the device.
- The device may only be used in dry surroundings and must not be used in the rain or at a relative humidity exceeding the operating conditions.
- Protect the device from permanent direct sunlight.
- Do not remove any safety signs, stickers or labels from the device. Keep all safety signs, stickers and labels in legible condition.
- Do not open the device.
- Observe the storage and operating conditions as given in the Technical data chapter.

## Intended use

Only use the device for air quality (CO<sub>2</sub> level), indoor temperature and humidity measurements within the measuring range specified in the technical data. Observe and comply with the technical data.

To use the device for its intended use, only use accessories and spare parts which have been approved by Trotec.

## Improper use

Do not use the device in potentially explosive atmospheres, for measurements in liquids or at live parts. Trotec accepts no liability for damages resulting from improper use. In such a case, any warranty claims will be voided. Any unauthorised modifications, alterations or structural changes to the device are forbidden.

## Personnel qualifications

People who use this device must:

- have read and understood the operating manual, especially the Safety chapter.

## Residual risks



### Warning of electrical voltage

There is a risk of a short-circuit due to liquids penetrating the housing!  
Do not immerse the device and the accessories in water. Make sure that no water or other liquids can enter the housing.



### Warning of electrical voltage

Work on the electrical components must only be carried out by an authorised specialist company!



### Warning

Risk of suffocation!  
Do not leave the packaging lying around. Children may use it as a dangerous toy.



### Warning

The device is not a toy and does not belong in the hands of children.



### Warning

Dangers can occur at the device when it is used by untrained people in an unprofessional or improper way!  
Observe the personnel qualifications!



### Caution

Keep a sufficient distance from heat sources.

## Note

To prevent damages to the device, do not expose it to extreme temperatures, extreme humidity or moisture.

## Note

Do not use abrasive cleaners or solvents to clean the device.

## Information about the device

### Device description

The CO<sub>2</sub> air quality monitor is a mains-powered measuring device with a comprehensive range of measurement options.

It comes with the following functional properties and equipment features:

- NDIR measurement of carbon dioxide concentrations in the room air
- Simultaneous indication of CO<sub>2</sub> values, room temperature, humidity level, date and time
- Minimum and maximum value function for CO<sub>2</sub>, air temperature and humidity
- Carbon dioxide alarm function with acoustic alarm for a freely definable limit value
- Additional CO<sub>2</sub> indicator icon (feel-good indication)

**Device depiction**

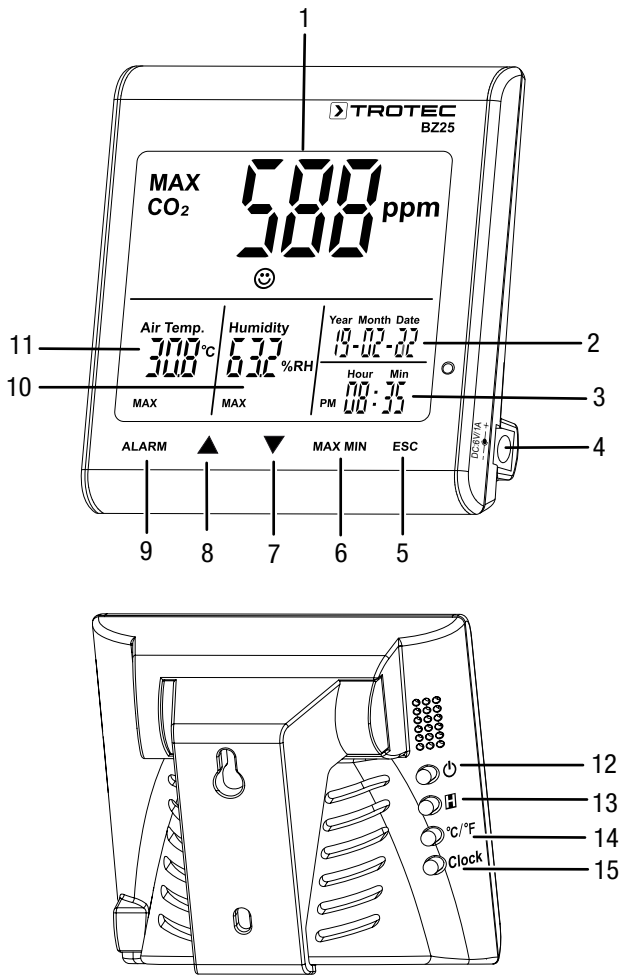

**Main display**

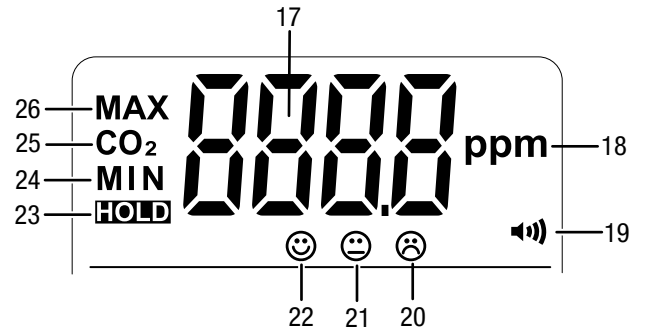

No.	Designation
17	Measured CO <sub>2</sub> value
18	Unit measured CO <sub>2</sub> value (parts per million)
19	Alarm activated indication
20	Feel-good indication: poor air quality
21	Feel-good indication: average air quality
22	Feel-good indication: good air quality
23	<i>HOLD</i> indication (freezing displayed values)
24	<i>MIN</i> indication (display of minimum values)
25	<i>CO<sub>2</sub></i> indication (display of CO <sub>2</sub> value)
26	<i>MAX</i> indication (display of maximum values)

No.	Designation
1	Main display
2	Date indication
3	Time indication
4	Power adapter input
5	<i>ESC</i> button
6	<i>MAX MIN</i> button
7	☺ button
8	☹ button
9	<i>ALARM</i> button
10	Relative humidity indication
11	Temperature indication
12	⏻ button (switch-on / switch-off)
13	⏸ button (hold)
14	°C/°F button
15	<i>Clock</i> button

## Technical data

Parameter	Value
<b>Model</b>	<b>BZ25</b>
Article number	3.510.205.014
Weight (packaging excluded)	190 g
Dimensions (length x width x height)	90 mm x 110 mm x 98 mm
Display	LCD (monochrome)
<b>Carbon dioxide (ppm)</b>	
Carbon dioxide sensor	NDIR sensor (non-dispersive infrared)
Measuring range	0 to 9999 ppm
Accuracy	±5 % or ±75 ppm
Resolution	1 ppm
<b>Relative humidity</b>	
Measuring range	0.0 % RH to 99.9 % RH
Accuracy	± 5 % RH
Resolution	0.1 %
<b>Air temperature</b>	
Measuring range	-5 °C to 50 °C or 23 °F to 122 °F
Accuracy	±1 °C or ±1.8 °F
Measuring range resolution	0.1 °C/°F
<b>Ambient conditions</b>	
Operation	-5 °C to 50 °C or 23 °F to 122 °F and 90 % RH (non-condensing)
Storage	-5 °C to 50 °C or 23 °F to 122 °F and 90 % RH (non-condensing)
Power supply	External (power adapter)

### Scope of delivery

- 1 x Measuring device BZ25
- 1 x Power adapter
- 1 x Operating manual

## Transport and storage

### Note

If you store or transport the device improperly, the device may be damaged.

Note the information regarding transport and storage of the device.

## Transport

The manufacturer packed the device to the best of his abilities to protect it against transport damage.

## Storage

When the device is not being used, observe the following storage conditions:

- dry and protected from frost and heat
- protected from dust and direct sunlight
- The storage temperature is the same as the range given in the Technical data chapter.

## Operation

### Connecting the power adapter

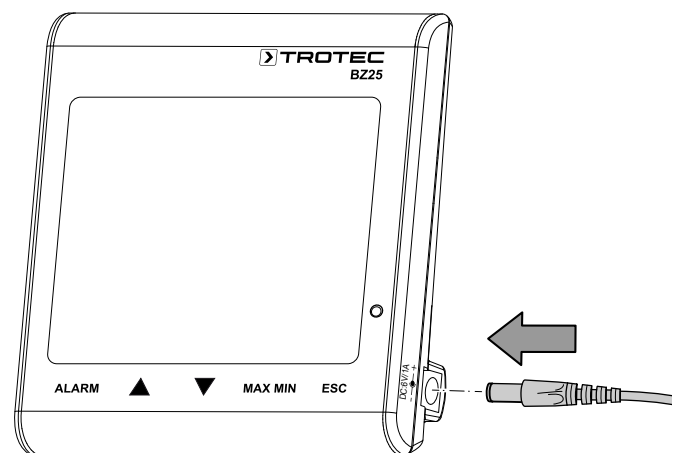

Prior to use, connect the device to the mains using the supplied power adapter.



### Start-up

Press the  button at the rear of the device for approx. 1 second to switch the device on. The device will then start a warm-up phase lasting 120 seconds.

### Setting date and time

Press and hold the *Clock* button for approx. 4 seconds to set time and date. The day indication starts flashing. Press the button again to switch between year, month, day, hours and minutes. Press one of the buttons  or  to increase or decrease the number flashing on the display. To exit the setting mode and to save the entered value press the *ESC* button once you have set the correct date and time.

### Hold function

Press the  button (hold) to permanently indicate or "freeze" the displayed values.

## Alarm function







The device features an alarm function that indicates when a previously set CO<sub>2</sub> threshold is exceeded.

Please proceed as follows to enable the alarm function:

1. Press the *ALARM* button.
  - ⇒ The alarm function is enabled and the alarm symbol  appears on the display. As soon as the measured value exceeds the previously set limit value, an acoustic alarm signal will be emitted and the buttons below the display start to flash in red.
2. Press the button again to exit or disable the alarm mode.



## Setting the limit value for the alarm function





Please proceed as follows to set a new limit value:

1. Press and hold the *ALARM* button for approx. 5 seconds.
  - ⇒ The previously set limit value appears on the display and the displayed alarm symbol  flashes.
2. Press  or  to increase or reduce the decrease the displayed number.
3. Then you can press the *ESC* button to exit the mode and to adopt the set value or to change the limit values for the feel-good indication   .

## Adjusting the limit values for the feel-good indication

### Note:

This setting can only be adjusted in the setting mode for the alarm threshold! After having set an alarm threshold, do not press the *ESC* button but rather the *ALARM* button again for a brief moment. The lower limit value for the feel-good indication will be displayed and the icons of the feel-good indication    start to flash.



1. Press  or  to increase or reduce the lower limit value for the feel-good indication.
2. Press the *ALARM* button to switch over to setting the upper limit value.
3. Press  or  to increase or reduce the upper limit value for the feel-good indication.
4. Press the *ESC* button to exit the mode and to adopt the set value.

## Displaying the minimum / maximum value

The device saves the highest and lowest display values. To call up these values, please proceed as follows:

1. Press the *MAX MIN* button.
  - ⇒ *MAX* appears on the display and the highest measured values for carbon dioxide, temperature and relative humidity will be displayed as well.
2. Press the button again to view the minimum values (*MIN*).
3. Press the *ESC* button to exit this mode.

## Background illumination

The background illumination will be switched on in addition by pressing either *ALARM*, *MAX MIN*,  or . The background illumination goes out after approx. 20 seconds of non-use. Press the *ESC* button to exit this mode.

## Setting the °C/°F indication

Press the °C/°F button at the rear of the device to switch between an indication in degrees Celsius and degrees Fahrenheit.

## Maintenance and repair

### Cleaning

Clean the device with a soft, damp and lint-free cloth. Make sure that no moisture enters the housing. Do not use any sprays, solvents, alcohol-based cleaning agents or abrasive cleaners, but only clean water to moisten the cloth.

### Repair

Do not modify the device or install any spare parts. For repairs or device testing, contact the manufacturer.

## Disposal



The icon with the crossed-out waste bin on waste electrical or electronic equipment stipulates that this equipment must not be disposed of with the household waste at the end of its life. You will find collection points for free return of waste electrical and electronic equipment in your vicinity. The addresses can be obtained from your municipality or local administration. For further return options provided by us please refer to our website [www.trotec24.com](http://www.trotec24.com).

The separate collection of waste electrical and electronic equipment aims to enable the re-use, recycling and other forms of recovery of waste equipment as well as to prevent negative effects for the environment and human health caused by the disposal of hazardous substances potentially contained in the equipment.

Trotec GmbH

Grebener Str. 7  
D-52525 Heinsberg

☎ +49 2452 962-400

☎ +49 2452 962-200

✉ [info@trotec.com](mailto:info@trotec.com)

[www.trotec.com](http://www.trotec.com)