

EN

OPERATING MANUAL
THERMOHYGROMETER



Table of contents

Notes regarding the operating manual..... 2

Safety 2

Information about the device..... 4

Transport and storage..... 6

Operation 6

Measurement principle 11

PC software..... 12

Maintenance and repair 13

Errors and faults..... 13

Disposal 13

Notes regarding the operating manual

Symbols

 **Warning of electrical voltage**
This symbol indicates dangers to the life and health of persons due to electrical voltage.

 **Warning of laser radiation**
This symbol indicates dangers to the health of persons due to laser radiation.

 **Warning**
This signal word indicates a hazard with an average risk level which, if not avoided, can result in serious injury or death.

 **Caution**
This signal word indicates a hazard with a low risk level which, if not avoided, can result in minor or moderate injury.

Note
This signal word indicates important information (e.g. material damage), but does not indicate hazards.

 **Info**
Information marked with this symbol helps you to carry out your tasks quickly and safely.

 **Follow the manual**
Information marked with this symbol indicates that the operating manual must be observed.

You can download the current version of the operating manual and the EU declaration of conformity via the following link:



T260



<https://hub.trotec.com/?id=44141>

Safety

Read this manual carefully before starting or using the device. Always store the manual in the immediate vicinity of the device or its site of use.

-  **Warning**
Read all safety warnings and all instructions. Failure to follow the warnings and instructions may result in electric shock, fire and/or serious injury. **Save all warnings and instructions for future reference.**
- This appliance can be used by children aged from 8 years and above and persons with reduced physical, sensory or mental capabilities or lack of experience and knowledge if they have been given supervision or instruction concerning use of the appliance in a safe way and understand the hazards involved. Children shall not play with the appliance. Cleaning and user maintenance shall not be made by children without supervision.
- Do not use the device in potentially explosive rooms or areas and do not install it there.
 - Do not use the device in aggressive atmosphere.
 - Do not immerse the device in water. Do not allow liquids to penetrate into the device.
 - The device may only be used in dry surroundings and must not be used in the rain or at a relative humidity exceeding the operating conditions.
 - Protect the device from permanent direct sunlight.
 - Do not expose the device to strong vibrations.
 - Do not remove any safety signs, stickers or labels from the device. Keep all safety signs, stickers and labels in legible condition.
 - Do not open the device.
 - Avoid looking directly into the laser beam.
 - Never point the laser beam at people or animals.
 - Observe the storage and operating conditions as given in the Technical data chapter.

Intended use

Only use the device for indoor measurements of temperature and humidity. Observe and comply with the technical data.

To use the device for its intended use, only use accessories and spare parts which have been approved by Trotec.

Improper use

Do not use the device in potentially explosive atmospheres, or for measurements in liquids.

Any unauthorised changes, modifications or alterations to the device are forbidden.

Never point the device at people or animals.

Personnel qualifications

People who use this device must:

- be aware of the dangers that occur when working with laser measuring devices.
- have read and understood the operating manual, especially the Safety chapter.

Safety signs and labels on the device

Note

Do not remove any safety signs, stickers or labels from the device. Keep all safety signs, stickers and labels in legible condition.

The following safety signs and labels are attached to the device:

CAUTION

LASER RADIATION
DO NOT STARE INTO BEAM

 **DIODE LASER**
P ≤ 1 mW Output at 675 nm

CLASS II
LASER PRODUCT 

Laser class 2, P max.: < 1 mW, λ: 675 nm
Do not look directly into the laser beam or the opening from which it emerges.
Never point the laser beam at people, animals or reflective surfaces. Even brief eye contact can lead to eye damage.
Examining the laser output aperture by use of optical instruments (e.g. magnifying glass, magnifiers and the like) entails the risk of eye damage.
When working with a laser of class 2, observe the national regulations on wearing eye protection.

Residual risks



Warning of electrical voltage

There is a risk of a short-circuit due to liquids penetrating the housing!

Do not immerse the device and the accessories in water. Make sure that no water or other liquids can enter the housing.



Warning of electrical voltage

Work on the electrical components must only be carried out by an authorised specialist company!



Warning of laser radiation

Laser class 2, P max.: < 1 mW, λ: 400-700 nm, EN 60825-1:2014



Do not look directly into the laser beam or the opening from which it emerges.

Never point the laser beam at people, animals or reflective surfaces. Even brief eye contact can lead to eye damage.

Examining the laser output aperture by use of optical instruments (e.g. magnifying glass, magnifiers and the like) entails the risk of eye damage.

When working with a laser of class 2, observe the national regulations on wearing eye protection.



Warning

Risk of suffocation!

Do not leave the packaging lying around. Children may use it as a dangerous toy.



Warning

The device is not a toy and does not belong in the hands of children.



Warning

Dangers can occur at the device when it is used by untrained people in an unprofessional or improper way! Observe the personnel qualifications!



Caution

When handling the device there is a risk of injury due to the exposed measuring tips.

Always put on the protective cap when not in use.



Caution

Keep a sufficient distance from heat sources.

Note

Exclusively use the original measuring tips included in the scope of delivery. Other measuring tips might bend or damage the holder at the measuring device.

Note

Never force the measuring device into the material to be measured or yank it out. Applying force can lead to bending or breaking of the measuring tips or to the destruction of the housing.

Note

To prevent damages to the device, do not expose it to extreme temperatures, extreme humidity or moisture.

Note

Do not use abrasive cleaners or solvents to clean the device.

Information about the device

Device description

The device comes equipped with the functions of a thermohygrometer and a pyrometer.

The device can capture the following measured values:

- Air temperature (°C, °F),
- Relative (% RH) and absolute humidity (g/m³),
- Dew point temperature (dp °C, dp °F),
- Mixing ratio (g/kg, gr/lb),
- Surface temperature (°C, °F).

The device features three different operating modes: TH mode, IR mode and IR DP mode.

In TH mode the device can use the functions of a thermohygrometer. The device measures air temperature, humidity and dew point temperature.

In IR mode the device can use the functions of a pyrometer. The device measures the surface temperature of objects.

The IR DP mode serves to detect critical surfaces on which condensation could take place due to drops below dew point. The device simultaneously indicates the surface temperature of the measuring object and the dew point temperature within the measurement environment.

A minimum, maximum and average function is available for the direct analysis of the measured data. Besides, the currently measured value can be recorded via the hold function.

The device can be operated via a capacitive touchscreen control panel. When not in use, an automatic switch-off saves the battery. The device is only intended for use inside buildings, because solar radiation (also scattered or indirect sunlight) compromises the measurement accuracy.

You can connect the device to a computer by using the USB cable included in the scope of delivery. Then you can extract and analyse your measured results with the optional MultiMeasure Studio software.

Device depiction

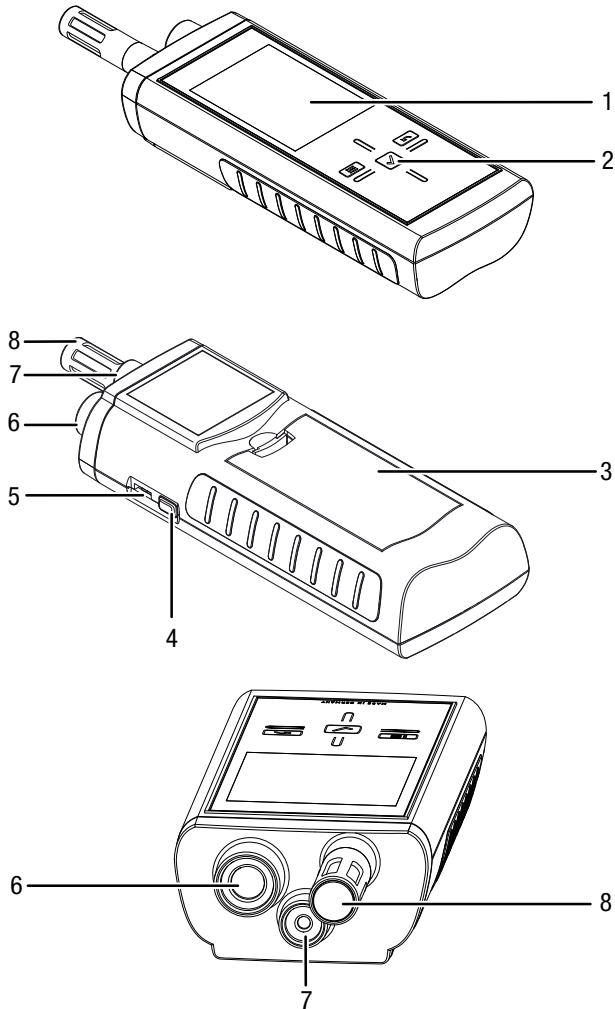

No.	Designation
1	Display
2	Cross control
3	Battery compartment with cover
4	Power button
5	USB interface
6	Infrared sensor with protective cap
7	Laser pointer
8	Measuring sensor

Cross control

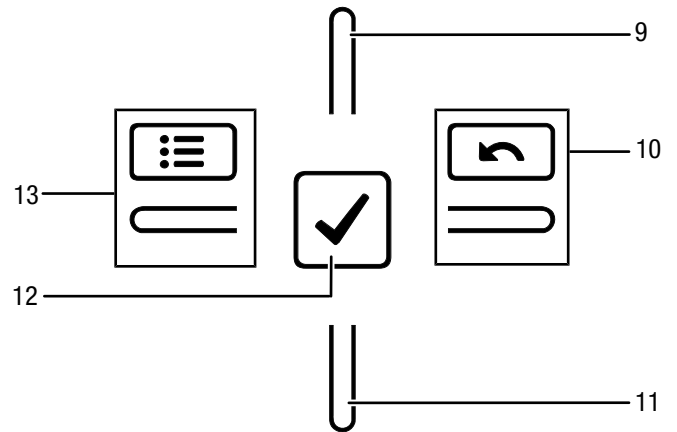

No.	Designation
9	Up button
10	Right/back button
11	Down button
12	OK button
13	Left/menu button

Display

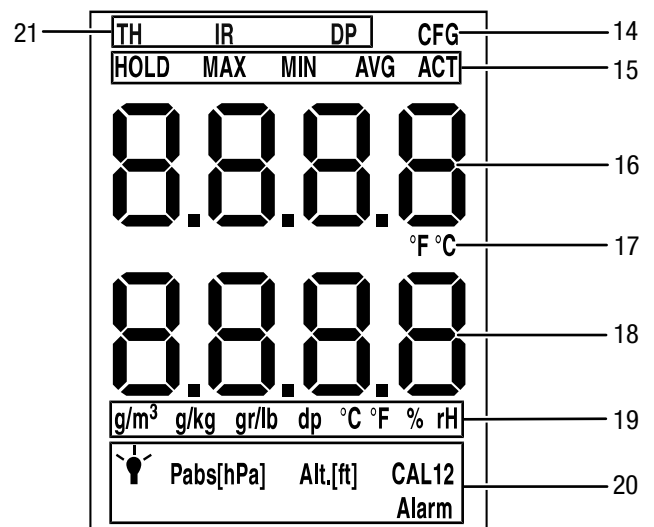

No.	Designation
14	CFG symbol (configuration mode display)
15	Measuring mode
16	Upper measured value indication (temperature)
17	Temperature unit
18	Lower measured value indication (humidity/dew point)
19	Unit for humidity or dew point
20	Configuration mode
21	Operating mode indication

Technical data

Parameter	Value
Model	T260
Temperature	
Sensor type	NTC
Measuring range	-20 °C to +50 °C or -4 °F to 122 °F
Accuracy	+/-0.4 °C or +/-0.7 °F
Resolution	0.1 °C or 0.1 °F
Relative humidity	
Sensor type	Capacitive
Measuring range	0.0 to 100.0 % RH
Accuracy	± 2 % RH
Resolution	0.1 % RH
Surface temperature	
Sensor type	Pyrosensor, Thermopile
Measuring range	-70 °C to +380 °C or -56 °F to 716 °F
Accuracy	+/-2 °C or +/-3 °F
Resolution	0.1 °C or 0.1 °F
Measuring optic (geometric resolution)	12 : 1
Degree of emission	0.95 (fixed)
General technical data	
Display	LCD
Measuring frequency	2 x per second
Interface	USB
Operating conditions	-20 °C to 50 °C with < 90 % RH (non-condensing)
Storage conditions	-20 °C to 60 °C with < 95 % RH (non-condensing)
Power supply	4 x 1.5 V, AA batteries
Weight	approx. 295 g
Dimensions (length x width x height)	202 mm x 63 mm x 35 mm

Scope of delivery

- 1 x Device T260
- 4 x 1.5 V batteries, type AA
- 1 x Factory test certificate
- 1 x Quick guide
- 1 x Display protection film
- 1 x USB cable

Transport and storage

Note

If you store or transport the device improperly, the device may be damaged.
Note the information regarding transport and storage of the device.

Transport

When transporting the device, ensure dry conditions and protect the device from external influences e.g. by using a suitable bag.

Storage

When the device is not being used, observe the following storage conditions:

- dry and protected from frost and heat
- protected from dust and direct sunlight
- The storage temperature is the same as the range given in the Technical data chapter.
- Remove the batteries from the device.

Operation

Inserting the batteries

Insert the supplied batteries before first use.



Caution

Make sure that the surface of the device is dry and the device is switched off.

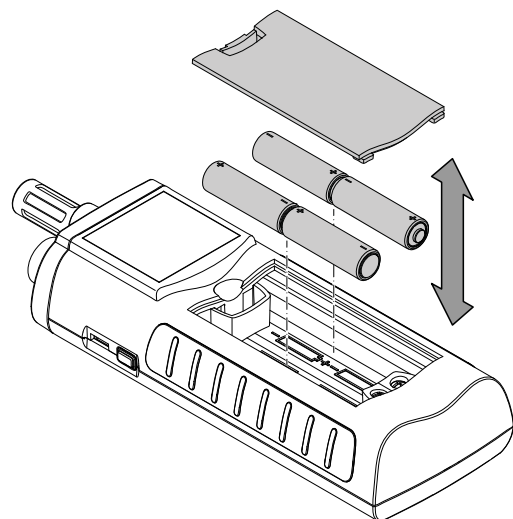

1. Remove the battery compartment cover (3).
 2. Insert the batteries with correct polarity.
 3. Insert the battery compartment cover (3).
- ⇒ The device can now be switched on.

Switch-on and measurements



Warning of laser radiation

Class 2 laser radiation.

Lasers of class 2 only radiate in the visible range and during continuous wave operation (lasting beam) no more than 1 milliwatt (mW) of output will be emitted. Looking directly into the laser beam for a longer period of time (more than 0.25 seconds) can cause damage to the retina.

Avoid looking directly into the laser beam. Never look into the laser beam using optical aides. Do not suppress the winking reflex when looking into the laser beam unintentionally. Never point the laser beam at people or animals.

Note:

Note that moving from a cold area to a warm area can lead to condensation forming on the device's circuit board. This physical and unavoidable effect can falsify the measurement. In this case, the display shows either no measured values or they are incorrect. Wait a few minutes until the device has become adjusted to the changed conditions before carrying out a measurement.

Please observe the information regarding the measurement principle.

The cross control is very sensitive. Therefore, avoid dirt on the control panel, because it could be misinterpreted by the device as keystroke.

Before use make sure that the touchscreen control panel is dirt-free.

If required clean the touchscreen control panel according to chapter *Cleaning the device*.

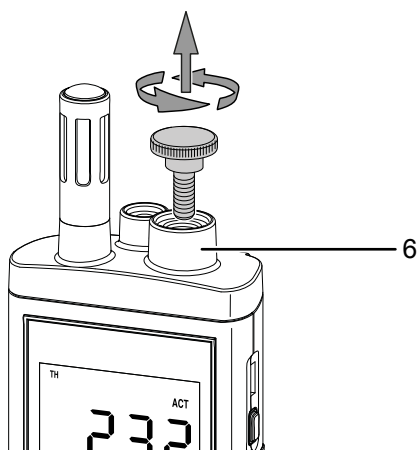

1. Remove the protective cap from the infrared sensor (6) if you want to carry out an infrared measurement. Otherwise leave the protective cap on the infrared sensor.

2. Press the On/Off button (4) until a beep is emitted.
 - ⇒ The device performs a short self-test.
 - ⇒ The device name and firmware version is shown on the display.
 - ⇒ The battery charge is indicated on the display.
 - ⇒ The device is ready for operation.
 - ⇒ The displayed units are based on the settings of the last utilization.
3. Select the desired measuring mode.
4. Point the device at the area to be measured.
 - ⇒ The measured values will be displayed.

Key lock

1. Briefly press the On/Off key (4) during operation.
 - ⇒ The device emits a short beep.
 - ⇒ *LoC on* is indicated on the display.
 - ⇒ Key lock is activated.
2. Press the On/Off key (4) again.
 - ⇒ The device emits a short beep.
 - ⇒ *LoC off* is indicated on the display.
 - ⇒ Key lock is no longer activated.

Operating mode

The device comes with three different operating modes.

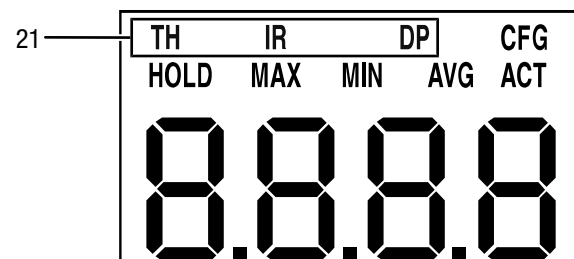

1. Press the Up key (9) to switch between the operating modes.
 - ⇒ The operating mode is indicated on the Operation mode display (21).

TH mode

- The device now has the functionality of a thermohygrometer.
- The upper measured value display (16) indicates the temperature.
To set the unit see *Temperature display configuration*.
- The lower measured value display (18) indicates either the humidity or the dew point.
To set the unit see *Humidity display configuration*.

IR mode



Danger

Class 2 laser radiation.

Lasers of class 2 only radiate in the visible range and during continuous wave operation (lasting beam) no more than 1 milliwatt (mW) of output will be emitted. Looking directly into the laser beam for a longer period of time (more than 0.25 seconds) can cause damage to the retina.

Avoid looking directly into the laser beam. Never look into the laser beam using optical aides. Do not suppress the winking reflex when looking into the laser beam unintentionally. Never point the laser beam at people or animals.

- As soon as IR mode is selected the laser pointer switches on. The laser pointer serves to mark the centre of the measuring spot.
- The device now has the functionality of a pyrometer. It measures the surface temperature of objects.
- The degree of emission for surfaces can be adjusted whilst in configuration mode.
- The upper measured value display (16) indicates the surface temperature.
To set the unit see *Temperature display configuration*.
- The lower measured value display (18) indicates either the humidity or the dew point.
To set the unit see *Humidity display configuration*.

IR DP mode



Danger

Class 2 laser radiation.

Lasers of class 2 only radiate in the visible range and during continuous wave operation (lasting beam) no more than 1 milliwatt (mW) of output will be emitted. Looking directly into the laser beam for a longer period of time (more than 0.25 seconds) can cause damage to the retina.

Avoid looking directly into the laser beam. Never look into the laser beam using optical aides. Do not suppress the winking reflex when looking into the laser beam unintentionally. Never point the laser beam at people or animals.

- As soon as IR DP mode is selected the laser pointer switches on. The laser pointer serves to mark the centre of the measuring spot.
- The device measures surfaces and dew point temperature in real time.

- When falling below the dew point temperature (see *Alarm function*) a visual signal (flashing laser, flashing **ALARM** display (20)) and, depending on the selected setting, an acoustic signal will be emitted.
- The upper measured value display (16) indicates the surface temperature.
- The lower measured value display (18) indicates the dew point temperature.

Configuration mode

1. Press the Left/menu key (13) for approx. 2 seconds.
⇒ The device emits a short beep.
⇒ The **CFG** symbol (14) is displayed in the upper right corner.
2. Use the buttons on the cross control (2) to select the desired option.

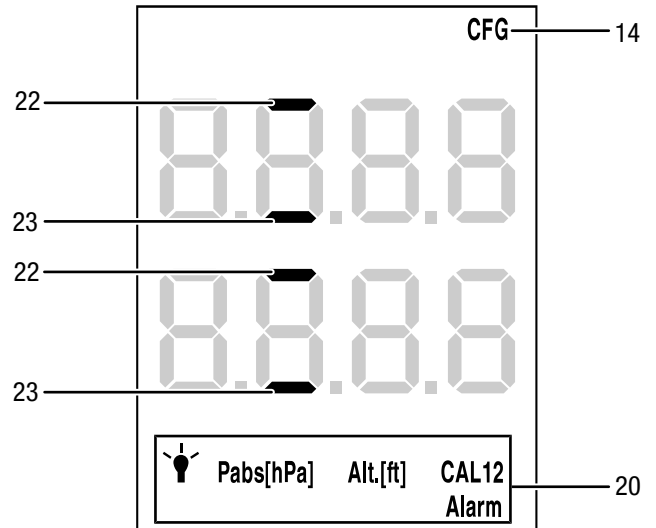

By use of **CAL** a single-point calibration can be carried out for the selected sensor indications. All sensors are already factory-calibrated and have a corresponding characteristic calibration curve. By stating a calibration value (offset) a global shift of the calibration curve, which has an effect on the entire measuring range, is performed for the single-point calibration! The offset value to be entered is that value by which the calibration curve will be shifted.

Example:

The displayed value is always "5" too high => change the offset value for this measurement channel to "-5".

The offset value's default setting is 0.0.

Configuration mode	Description
Lamp	Setting brightness. Available are values between 20 and 100 and AL.on. Switch-off after 30 min unless with setting AL.on.
Pabs[hPa]	Only available when the unit g/kg is active. Specifying the absolute pressure (value range: 600 and 1200 hPa). 1. Enter the value using the cross control (2). 2. Confirm with the OK button (10).
Alt.[ft.]	Only available when the unit gr/lb is active. Specifying the local altitude in feet (value range: -999 und 9999 ft). 1. Enter the value using the cross control (2). 2. Confirm with the OK button (10).
CAL1 (TH mode)	Specifying the temperature offset. (value range: -10 to +10 °C or -18 to +18 °F) Set the degree of emission. (value range: 0.1 to 1.0) 1. Enter the value using the cross control (2). 2. Confirm with the OK button (12).
CAL1 (IR mode)	Specifying the temperature offset. (value range: -10 to +10 °C or -18 to +18 °F) A negative offset allows no measured values of less than 0.00. 1. Enter the temperature offset value using the cross control (2). 2. Press the OK button (12) for 2 s. 3. Enter the emissivity value using the cross control (2). 4. Press the OK button (12) for 2 s.
CAL2	Only available when % rH is active. Specifying the offset for relative humidity (value range: +/- 30 % RH). A negative offset allows no measured values of less than 0.00. 1. Enter the value using the cross control (2). 2. Confirm with the OK button (10).
ALARM	Only available when IR DP is active Stipulating the upper (<i>Hi</i>) and lower (<i>Lo</i>) threshold value for the dew point temperature. value range: up to 9.9 °C or 9.9 °F 1. Enter the value for <i>Hi</i> using the cross control (2). 2. Press the OK button (12) for 2 s. 3. Enter the value for <i>Lo</i> using the cross control (2). 4. Press the OK button (12) for 2 s. 5. Switch the acoustic and visual signal on or off by use of the Up (9) and Down (11) keys. ⇒ If the bars (22) in the upper and lower measured value display are flashing, the acoustic and visual signal is activated. ⇒ If the bars (23) in the upper and lower measured value display are flashing, the acoustic and visual signal is deactivated.

Alarm function

In IR DP mode the alarm function is activated automatically. Alarm triggering and intensity are defined by the upper and lower alarm threshold.

These two limit values can be calculated from the measured dew point temperature (*TdP*) and the threshold values individually determined in configuration mode: upper threshold (*Hi*) and lower threshold (*Lo*).

The sum of dew point temperature (*TdP*) and upper threshold value (*Hi*) constitutes the upper alarm limit value (*TdP + Hi*).

The difference of dew point temperature (*TdP*) and lower threshold value (*Lo*) constitutes the lower alarm limit value (*TdP - Lo*).

If the surface temperature falls below the upper alarm limit (*TdP + Hi*) an acoustic and visual alarm (flashing laser and flashing **ALARM** display) is triggered which intensifies in proportion to the increased approximation to lower alarm limit.

The more the surface temperature drops, the faster increases the repetition frequency of the acoustic and visual signals. Maximum repetition frequency is triggered when reaching the lower alarm limit (*TdP - Lo*).

Example: The current dew point temperature (*TdP*) is +10 °C. You define the upper threshold (*Hi*) as 5 °C and lower threshold (*Lo*) as 5 °C. Then the alarm starts at +15 °C (*TdP + Hi*) and reaches maximum intensity at 5 °C (*TdP - Lo*).

Temperature display configuration

The temperature can be displayed in either Celsius (°C) or Fahrenheit (°F).

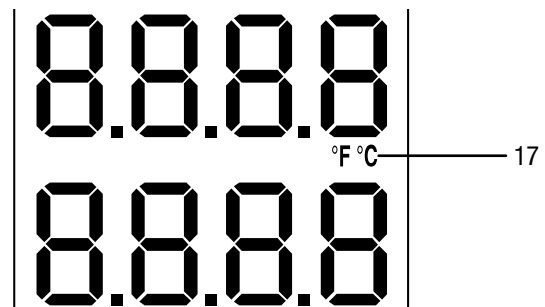

- Press the Up key (9) to switch between °C and °F.
 - ⇒ The temperature will be displayed in the selected unit.
 - ⇒ The unit (17) will be indicated on the display (1).

Operating mode	Temperature unit	Description
TH	°C	Air temperature in °C
	°F	Air temperature in °F
IR	°C	Surface temperature in °C
	°F	Surface temperature in °F
IR DP	°C	Surface temperature in °C
	°F	Surface temperature in °F

Humidity display configuration

The humidity can be displayed in % RH, g/m³, g/kg and gr/lb, and the dew point temperature in dp °C and dp °F.

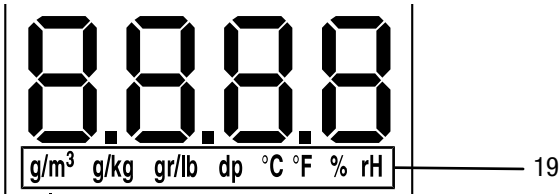

- Press the down key (11) until the desired unit is displayed.
 - ⇒ The humidity or dew point temperature will be displayed in the selected unit in the lower measured value display (18).
 - ⇒ The unit (19) will be indicated on the display (1).

Unit	Description
g/m ³	Absolute humidity in g/m ³
g/kg	Specific humidity in g/kg
gr/lb	Specific humidity in gr/lb
dp °C	Dew point temperature in °C
dp °F	Dew point temperature in °F
% RH	Relative humidity in per cent

Measuring mode

- Press the keys Right/back (10) or Left/menu (13) until the desired measuring mode is displayed.
- The selected measuring mode (15) will be indicated on the display (1)

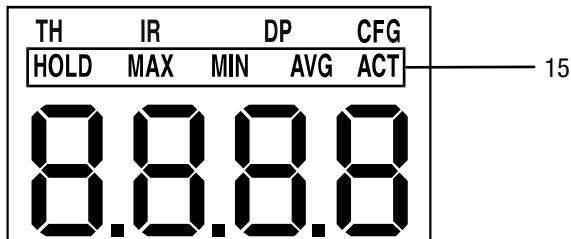

The device comes with the following measuring modes:

Measuring mode	Description
ACT	Measured value in real time
AVG	Average value of measurements since switch-on
Min	Minimum measured value
Max	Maximum measured value
HOLD	Measured value will be held
TH	The device shows the air temperature and humidity (like a thermohygrometer).
IR	The device shows the surface temperature (like a pyrometer).
IR DP	The device shows both dew point and surface temperature (combination of thermohygrometer and pyrometer).

Holding the measured value

- Set the measuring mode to *HOLD*.
 - ⇒ The current measured value will be held and displayed.
 - ⇒ The device will hold this value until the measured values are set back or the device is switched off.

Resetting the measured values

- Press the OK button (12) for approx. 2 seconds.
 - ⇒ All previously stored measured values of the measuring modes *AVG*, *MIN*, *MAX* and *HOLD* will be set back.
 - ⇒ All previously stored measured values of the measuring modes *AVG*, *MIN*, *MAX* and *HOLD* will be set back.

Measured value storage

Please note that measured values cannot be saved on the device itself. In order to save measured values, the device has to be connected to a PC via a USB cable using the MultiMeasure Studio software.

- Briefly press the OK button (12).
 - ⇒ The displayed measured value will be saved in the software.

Further information can be gathered from the help text of the MultiMeasure Studio software.

Laser pointer



Danger

Class 2 laser radiation.

Lasers of class 2 only radiate in the visible range and during continuous wave operation (lasting beam) no more than 1 milliwatt (mW) of output will be emitted. Looking directly into the laser beam for a longer period of time (more than 0.25 seconds) can cause damage to the retina.

Avoid looking directly into the laser beam. Never look into the laser beam using optical aides. Do not suppress the winking reflex when looking into the laser beam unintentionally. Never point the laser beam at people or animals.

As soon as operating mode IR or IR DP is selected, the laser pointer switches on. The laser pointer is on for a maximum of 2 minutes and can then be reactivated for another 2 minutes by briefly pressing the OK button (12).

USB interface

The device can be connected to a PC via the USB interface (5). See chapter *PC software*.

Switch-off

- Press and hold the On/Off button (4) for approx. 3 seconds until a beep is emitted.
 - ⇒ The device is switched off.
- If applicable, put the protective cap back on the infrared sensor.

Measurement principle

The device comes with a measuring sensor for air temperature and humidity.

It is further equipped with an infrared sensor for the measurement of surface temperatures.

The degree of emission and the ratio of the distance to and the size of the measuring spot play an important role when using the infrared sensor for measurements.

Degree of emission

The degree of emission is used to describe the energy radiation characteristics of a material.

The higher this value, the higher is the ability of the material to radiate. Many organic materials and surfaces have a degree of emission of approx. 0.95.

Metal surfaces or shiny materials have a lower degree of emission and therefore only yield inaccurate measured values. Please observe this when using the device.

In order to compensate this, the surface of shiny parts can be covered with adhesive tape or matt black colour.

The device is unable to measure through transparent surfaces such as glass. Instead it measures the surface temperature of the glass.

A material's degree of emission depends on various factors such as the material composition, its surface condition and temperature. (In theory,) It can be between 0.1 and 1.

As a rule of thumb we can assume: When a material is rather dark and its surface texture matt, it probably has a high emissivity. The brighter and smoother the surface of a material, the lower will be its degree of emission, presumably. The higher the degree of emission of the surface to be measured, the better it is suited for non-contact temperature measurement by use of a pyrometer or thermal imaging camera, since falsifying temperature reflections become negligible.

Measuring distance and measuring spot size (Distance to Spot ratio, D:S)

In order to achieve precise measurement results the measuring object must be larger than the device's measuring spot. The determined temperature is the average temperature of the measured area. The smaller the measuring object, the shorter the distance to the device.

You can gather the precise diameter of the measuring spot from the figure below.

For accurate measurements the measuring object should be at least twice as large as the measuring spot.

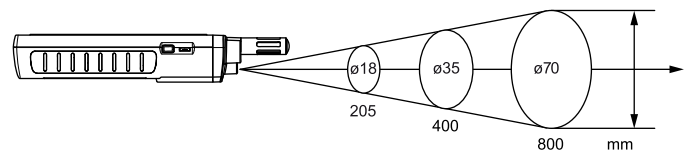

PC software

Use the MultiMeasure Studio Standard PC software (free standard version) or MultiMeasure Studio Professional (paid professional version, dongle required) to carry out a detailed analysis and visualisation of your measured results. You can only use all configuration, visualisation and functional options of the device when using this PC software and a TROTEC® USB dongle (professional).

Installation requirements

Ensure that the following minimum requirements for installing the MultiMeasure Studio Standard or MultiMeasure Studio Professional PC software are fulfilled:

- Supported operating systems (32 or 64 bit version):
 - Windows XP from service pack 3
 - Windows Vista
 - Windows 7
 - Windows 8
 - Windows 10
- Software requirements:
 - Microsoft Excel (to display stored Excel files)
 - Microsoft .NET Framework 3.5 SP1 (is automatically installed during software installation, where applicable)
- Hardware requirements:
 - Processor speed: 1.0 GHz, minimum
 - USB connection
 - Internet connection
 - 512 MB RAM, minimum
 - 1 GB hard disk space, minimum
 - optional: TROTEC® USB dongle (Professional) for using the professional version of the PC software

Installing the PC software

1. Download the current PC software from the Internet. To do so, visit the website www.trotec.de. First click on products and services, then on services and downloads. Then select Software in the category menu. Select the MultiMeasure Studio Standard software from the list. If you want to use the optionally available professional version of the PC software "MultiMeasure Studio Professional" (dongle), then get in touch with your TROTEC® customer service.
2. Double-click on the downloaded file to start the installation.
3. Follow the instructions of the installation wizard.

Starting the PC software

1. Connect the device to your PC via the USB connection cable provided in the scope of delivery.

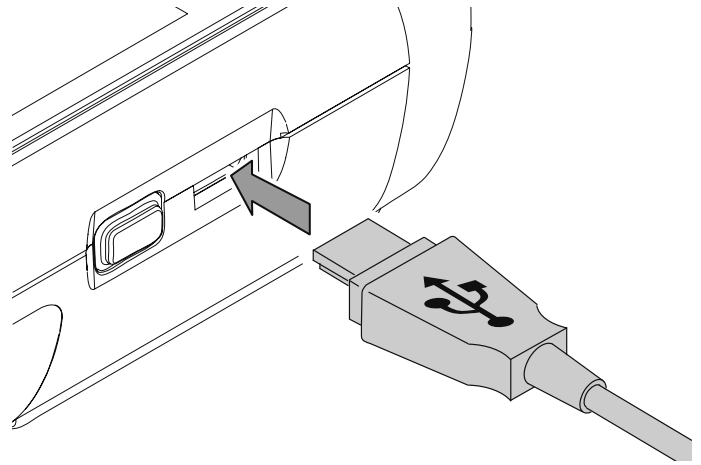

Note

Step 2 only needs to be performed, when using the Professional software functions.

If you only use the Standard software functions, please proceed to step 3.

2. In order to enable the Professional functions, connect the TROTEC® USB dongle to a free USB port on your PC. The TROTEC® USB dongle (Professional) is automatically detected by the operating system. If you only connect the TROTEC® USB dongle (Professional) to your PC after starting the PC software, click the "Parameters" menu item in the PC software. Afterwards, click the USB symbol (dongle check) to read the connected TROTEC® USB dongle (Professional).
3. Switch the device on (see chapter *Switch-on and measurements*).
4. Start the MultiMeasure Studio software. Depending on the activation process you will be asked to insert the access code that has been previously assigned to you. Only then the dongle for releasing the according Professional tools of the software will be activated.



Note

Information regarding the use of the MultiMeasure Studio software is provided in the help text of the software.

Maintenance and repair

Battery change

Change the batteries when the message *Batt lo* is displayed upon switch-on or the device can no longer be switched on. See chapter Operation *Inserting the batteries*.

Cleaning

Clean the device with a soft, damp and lint-free cloth. Make sure that no moisture enters the housing. Do not use any sprays, solvents, alcohol-based cleaning agents or abrasive cleaners, but only clean water to moisten the cloth.

Cleaning the infrared sensor

If the infrared sensor is dirty, you can carefully blow it off.

Repair

Do not modify the device or install any spare parts. For repairs or device testing, contact the manufacturer.

Errors and faults

The device has been checked for proper functioning several times during production. If malfunctions occur nonetheless, check the device according to the following list.

The device does not switch on:

- Check the charging status of the batteries. Change the batteries when the message *Batt lo* is displayed upon switch-on.
- Check that the batteries are properly positioned. Check the polarity is correct.
- Never carry out an electrical check yourself; instead, contact your TROTEC® customer service.

Disposal



The icon with the crossed-out waste bin on waste electrical or electronic equipment stipulates that this equipment must not be disposed of with the household waste at the end of its life. You will find collection points for free return of waste electrical and electronic equipment in your vicinity. The addresses can be obtained from your municipality or local administration. For further return options provided by us please refer to our website <https://de.trotec.com/shop/>.

The separate collection of waste electrical and electronic equipment aims to enable the re-use, recycling and other forms of recovery of waste equipment as well as to prevent negative effects for the environment and human health caused by the disposal of hazardous substances potentially contained in the equipment.



In the European Union, batteries and accumulators must not be treated as domestic waste, but must be disposed of professionally in accordance with Directive 2006/66/EC of the European Parliament and of the Council of 6 September 2006 on batteries and accumulators. Please dispose of batteries and accumulators according to the relevant legal requirements.

Trotec GmbH

Grebener Str. 7
D-52525 Heinsberg

☎ +49 2452 962-400

☎ +49 2452 962-200

✉ info@trotec.com

www.trotec.com